



SHELDON THEATRE

— of —
P E R F O R M I N G
A R T S

Technical Contact:

Production Manager:

Russell Johnson

651-388-8705

rjohnson@sheldontheatre.org

Location:

Sheldon Theatre:

443 W. 3rd St., Red Wing, MN 55006

www.sheldontheatre.org

DIRECTIONS TO THE SHELDON THEATRE:

From Minneapolis/St. Paul:

- Take I-94 or I-494 to the eastside and Highway 61
- As you enter downtown Red Wing, Highway 61 becomes Main Street
- TURN RIGHT at the 5th stoplight on the corner Main Street and Bush Street (the St. James hotel is on the left)
- Drive one block to 3rd Street and TURN RIGHT. The Sheldon Theatre is located on the corner of 3rd St. and East Ave. (across from the Red Wing Public Library).

From Rochester, MN:

- As you enter Red Wing, Highway 58 becomes Plum St.
- TURN LEFT on 3rd St. at the 2nd stoplight (across from Liberty's Restaurant)
- Drive 2 blocks on 3rd St. The Sheldon Theatre is on the corner of 3rd St. and East Ave (across from the Red Wing Public Library)

From Wisconsin:

- As you enter Red Wing, Highway 63 becomes 3rd St.
- Drive 3 blocks on 3rd St. The Sheldon Theatre is located on the corner of 3rd St. and East Ave. (across from the Red Wing Public Library).

POLICIES:

The Sheldon Theatre is a smoke-free facility. No food or drink is allowed onstage or in the house.

PARKING:

Truck parking: (contact Sheldon Production Director to arrange) on east side of Sheldon Theatre

Car Parking: available for free in 4th St. or Main St. ramps.

LOADING DOCK:

East side of Sheldon Theatre in alley. Enter alley at either Bush St. or East Ave.

Dock door dimensions: 5'10" wide x 10'6" high

Dock height: unload to ground with 8" curb to door

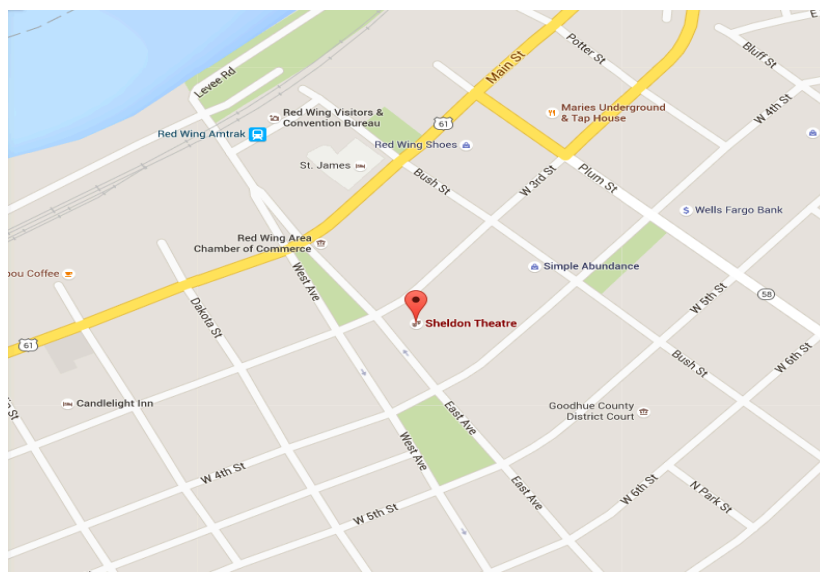

GENERAL INFORMATION:

- Seating:** The Sheldon Theatre seats 466 patrons (287 orchestra level and 179 balcony level)
- Main Lobby:** Includes a ticket office and refreshment bar. Limited space is available for artist product merchandise sales.
The Sheldon is able to provide sellers and a cash box (please arrange with Sheldon Production Director in advance)

STAGE INFORMATION:

- Playing Area:** Apron at stage level: 32'0" wide x 40'0" deep x 15'0" high with thrust
Upstage of plasterline: 32'0"W x 32'0"D x 15'0"H
Apron: 32'0"W x 8'0"D x 15'0"H
- Orchestra Pit:** 32'0"W x 12'0" D x 12'0" H
- Wing Space:** Stage Left: 9'10"W x 23'0"D x 15'0"H
Stage Right: 13'5"W x 23'0"D x 15'0"H
- Stage/Deck Surface:** Tongue and groove fir, painted flat black. Small screws possible, but no hole drilling
- Soft Goods:** Grand Drape is burgundy colored and can traverse or guillotine
(3) sets black legs- 21'0"H x 12'0"W
(3) black borders- 8'0"H x 40'0"W
(1) white cyc- 23'0"H x 40'0"W
(1) light blue cyc- 23'0"H x 40'0"W
(1) white scrim- 24'0"H x 40'0"W
(1) black scrim- 22'0"H x 32'0"W
(1) movie screen (in repertory position: Lineset 9) front projected-
screen is 15'6"H x 28'0"W with black frame
projection surface is 12'H x 26'W
(1) star drop- 21'0"H x 39'0"W with 1 lighting circuit
- Fly System:** 30 line set manual counterweight system, locking rail located stage left at stage level
Grid Height: 40'0"
Maximum fly height: 36'0"
Minimum fly height: 4' working height
- Staging Inventory:** (4) black wooden stools
(1) Genie Lift (30' maximum height)
(1) 12' stepladder
(1) 6' stepladder

SHELDON THEATRE LINESET SCHEDULE

Sheldon Theatre
Red Wing, MN

SHOW NAME:
Load In:

LS	DISTANCE	2016 Rep Hang	SHOW HANG	OC	TRIM	SIZE (W x H)	NOTES
PL	0'-0"	PLASTER LINE					DS edge at proscenium
FC	0'5"	FIRE CURTAIN					Must remain clear at all times
		MAIN VALANCE					Fixed batten
1	1'-3"	House Curtain				2@ 21' x 21'	Track stays on pipe always, curtain splits center
2	2'-0"	Black Legs		13'	21'	2@ 21'h x 12'w	
3	3'-3"	Aux Electric					permanent mounted circuit raceway
4	4'-3"	Black Border			19'	8'h x 40'w	
5	5'-2"	Olio Drop					painted drop
6	5'-11"	1st Electric			20'		permanent mounted circuit raceway
7	6'-8"						
8	7'-5"	Black Legs		13'	21'	2@ 21'h x 12'w	
9	8'-2"	Movie Screen				15'6"h x 28'w	projection surface= 12'h x 26'w
10	8'-11"						
11	9'-8"						
12	10'-5"	Black Border			19'	8'h x 40'w	
13	11'-2"						
14	12'-2"	2nd Electric			20'		permanent mounted circuit raceway
15	13'-5"	Black Traveler					
16	14'-2"	Black Border			19'	8'h x 40'w	
17	16'-5"						
18	17'-2"						
19	17'-11"	Black Scrim				22'h x 32'w	
20	18'-8"	White Scrim				24'h x 40'w	
21	19'-5"						
22	20'-1"	Black Border				8'h x 40'w	
23	20'-11"	Black Legs		13'	21'	2@ 21'h x 12'w	
24	21'-11"	3rd Electric			20'		permanent mounted circuit raceway
25	23'-2"						
26	23'-9"	Cyc Lights			20'		permanent mounted circuit raceway
27	24'-3"	Star Drop				21'h x 39'w	
28	24'-9"	White Cyc				23'h x 40'w	
29	25'-3"	Light Blue Cyc				23'h x 40'w	
30	25'-9"	Blackout Drop				21'h x 44' w	
BW	32'-0"	BACK WALL					natural red brick

NOTES:

- Spacing between battens is uneven.

LIGHTING INFORMATION:

For more details, please reference lighting repertory plot and paperwork on following pages. Plot and paperwork are available in other formats (please connect with Sheldon Director of Production in advance for updates to lighting plot and current status thereof)

Lighting Control: Lighting booth is located at FOH on 3rd floor (75' from stage)
ETC Element 60/500 control console
(190) 2.4K CD-80 Dimmers

Lighting units in rep: (9) ETC Source 4 14 deg 750w
(4) ETC Source 4 19 deg 575w
(24) ETC Source 4 36 deg 575w
(4) ETC Source 4 50 deg 575w
(24) ETC Source 4 PAR WFL 575w
(8) Phoenix 19 750w
(14) Phoenix 36 750w
(1) Phoenix 50 750w
(12) D40 Vivid SELR75 161w
(8) SS-Cyc 200 200w

Lighting inventory: (2) Rosco Alpha 900 foggers with wired remotes
(3) LeMaitre Neutron XS hazers with wired remotes

Full Stage Blackout
Sky Blue Cyc
White Cyc

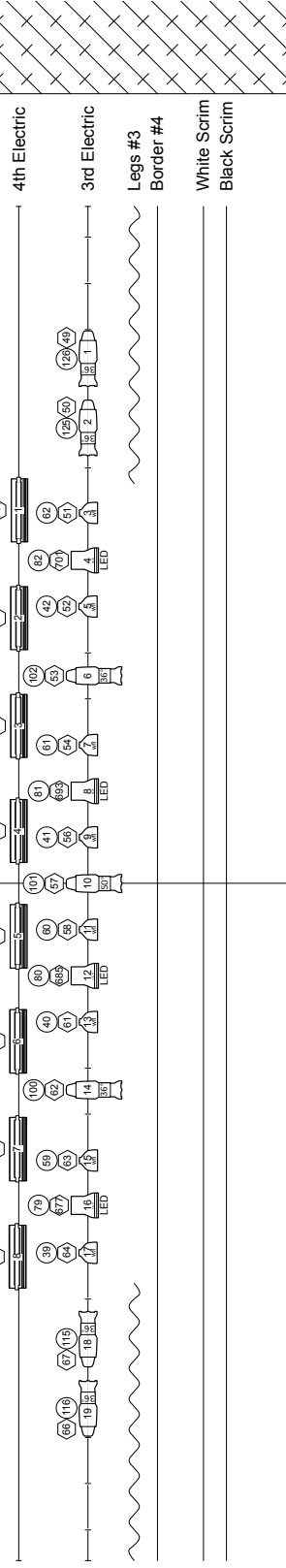

Border #3
Midstage Traveler
Fly Rail

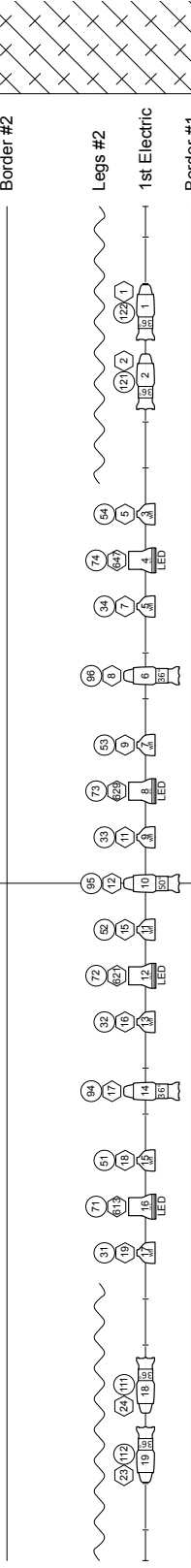

Border #1
Aux Electric
Legs #1
House Curtain

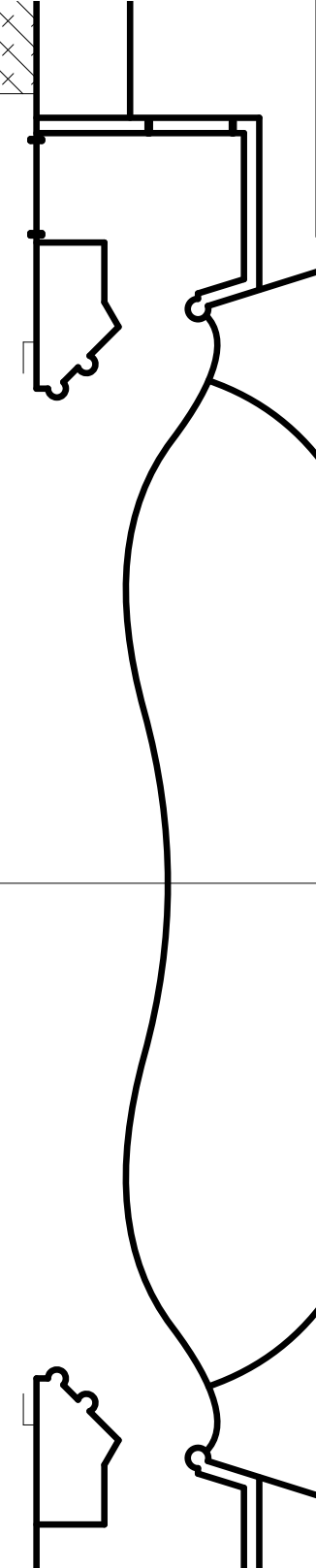

The Sheldon Theatre	
Lighting 8.5x11 Stage	Date: 12/23/2015
Ray Wigg, M.A.	Scale: Sheet Scale
Production Director: Russell Johnson	
Contact Info: 651-986-6705	
Revisors: 12/23/2015	
A	OF
	1

Positions Not Drawn in actual locations.

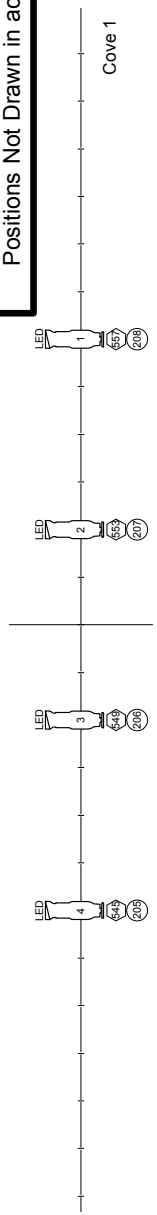

Light

	Etc Source 4 14°
	ETC Source-4 19°
	ETC Source-4 36°
	ETC Source-4 50°
	Phoenix 19
	Phoenix 36
	Phoenix 50
	ETC Source 4 PAR MCM (WFL)
	SS-Cyc 200

Typical

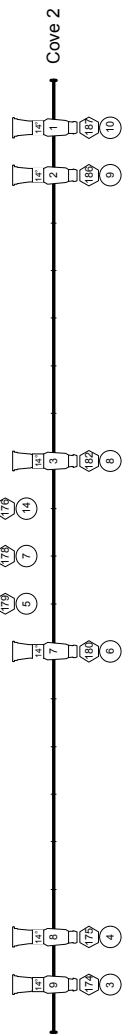
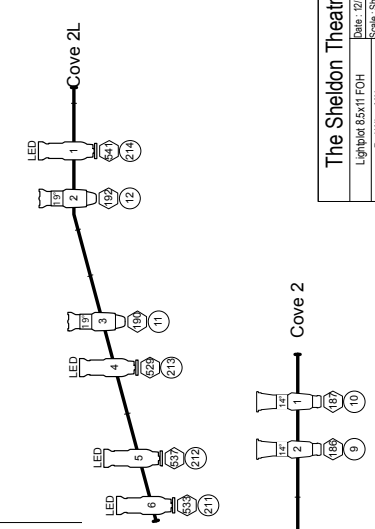
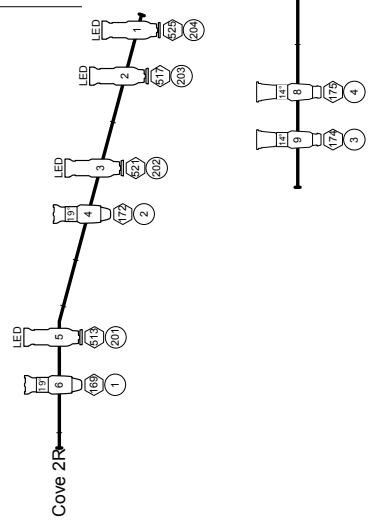
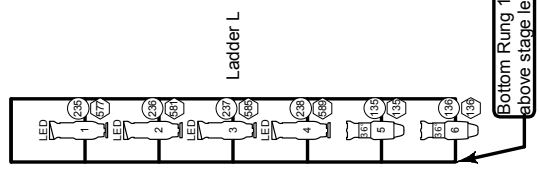
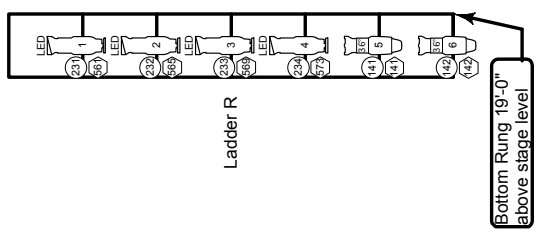

AUDIO INFORMATION:

Audio Control: Digico SD-9 Surface & Two D-Rack located at the rear of the orchestra level seats
48 Flexi-channels
8 stage outputs plus front fill and 2 side fill sockets
Amps: EV TG5's run by IRIS software system

Speaker Systems:

Stationary: Dynacord PWH Subwoofers
with (2) Dynacord Cobra tops per side (house left and house right)
Under Balcony fills: (4) Dynacord VL 262
Balcony fills: (1) EV ETX12P
Side fills: (4) EV ZX5-60B

Portable: Monitor wedges: (8) EV XW15A
Drum Monitors: (1) EV ETX 35p kick monitor and (1) EV ETX-15sp kick sub

Playback: (1) TASCAM CD-160 CD player
(1) TASCAM 112 MKII cassette player
(1) PC or MAC computer can be made available (arrange with PM in advance)

Backline Inventory: (1) Steinway 7' Grand piano
(1) Blonde Upright Piano
(1) NORD Stage 2 88EX keyboard
(2) Keyboard "X" stands
(1) Aguilar AG700 Bass Head with 4x10 4ohm Cabinet
(1) Kilgen Theatre Organ
(1) Yamaha, 5-piece Drum kit complete
(1) Fender Twin Reverb guitar amplifier
(1) Fender Bassman guitar amplifier

Audio staging:

(1) 8'x8' drum riser
(10) Wenger platform triangles (8"H)
(1) conductor podium (6"H)
(70) black padded straight back concert chairs
(40) concert music stands
(36) music stand lights

Audio Mic inventory: (8) Shure SM 57

(12) Shure SM 58
(6) Shure Beta 58A
(3) Sennheiser ew 300 G3 wireless handheld
(3) Shure SM 81
(2) Sennheiser 421
(2) Unipoint 853
(1) Shure Beta 52A
(10) Sennheiser ew 300 GE lavalier wireless

- (2) TAKSTAR PCM 6100
- (2) PCC 1600
- (1) EV PL 80 vocal
- (1) EV PL 77B vocal
- (2) Earthworks SR 77 cardioid
- (5) Countryman DI's
- (3) Rapco Passive DI's
- (2) AT - 4041

(1) AT Drum Kit Mic Package with:

- (3) MB 5K
- (1) MB 6K
- (1) SHURE 52A
- (1) SHURE 91A

VIDEO INFORMATION:

- (1) Sanyo multimedia PLC-XF46N/E (1.2K) located on the center of the balcony rail
can support video or data

COMMUNICATION:

- (6) Clear Com headsets
paging system to non-public areas located downstage right

POWER:

- 100 amp three-phase service located in basement
100' from stage entrance

DRESSING ROOMS:

- (2) makeup/dressing rooms located downstairs next to green room

each room with shower, toilets and clothes racks to accommodate 6 people
Locker room

GREEN ROOM:

Located directly under the stage. Includes small kitchen, vending machines, microwave, conventional ovens, lounge/eating area and stage monitor

WARDROBE:

- A laundromat is available approximately 4 blocks from the theatre
(2) steamers

AMENITIES/HOSPITALITY:

Airport Services: the closest full service airport is Minneapolis/St. Paul International, located (1) hour north of Red Wing on Highway 61 and Interstate 494

Local Accommodations:

St. James Hotel: 406 Main St., Red Wing MN 55066 651-388-2846

AmericInn: 1819 Old West Main St., Red Wing MN 800-634-3444

Best Western Hotel: Hwy 61/232 Withers Harbor Dr., Red Wing MN 55066
651-388-1577

Nichols Inn: 1750 Hwy 61, Red Wing MN 55066 651-388-6633

Days Inn: 955 E. 7th St., Red Wing MN 55066 651-388-3568

Local Hospital with ER:

Mayo Clinic Health System in Red Wing

701 Hewitt Blvd, Red Wing MN 55066

651-267-5000 toll free 866-297-9215

Local Banks:

Merchants Bank: 2835 South Service Drive, Red Wing MN 55066 651-385-7621

Wells Fargo Bank: 401 Plum St., Red Wing MN 55066 651-388-6751

Restaurants:

There are numerous restaurants, cafes, coffee shops and a bakery within close walking distance of the theatre